

Dimensions

518

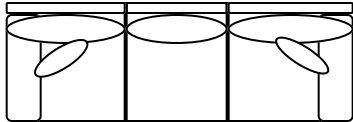

-011 3 over 3 Sofa
85x34x35

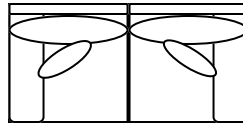

-019 Loveseat
62x34x35

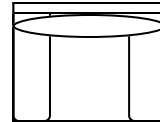

-001 Chair
39x34x35

518 - use 729-109
Ottoman
30x24x17

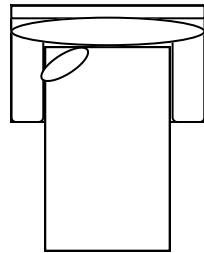

-092 Chaise
42x61x35

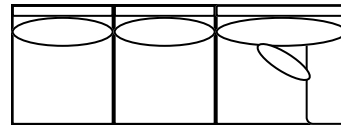

-080 RSF One Arm Sofa
-017 RSF One Arm Q Sleeper
77x34x35

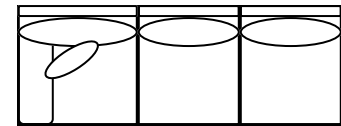

-081 LSF One Arm Sofa
-018 LSF One Arm Q Sleeper
77x34x35

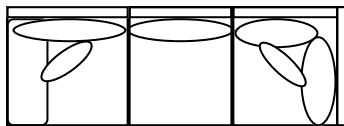

-0A3 LSF One Arm Sofa Section
90x34x35
To be used with one-arm sofa, sleeper, loveseat, or chair only.
Will create a 90" L-shaped sectional.

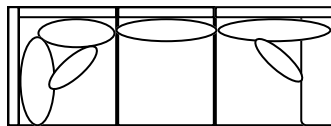

-0A4 RSF One Arm Sofa Section
90x34x35
To be used with one-arm sofa, sleeper, loveseat, or chair only.
Will create a 90" L-shaped sectional.

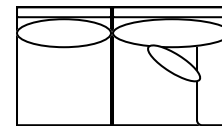

-084 RSF 1-Arm Loveseat
54x34x35

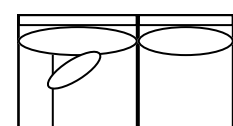

-086 LSF 1-Arm Loveseat
54x34x35

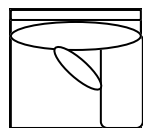

-030 RSF 1-Arm Chair
-031 LSF 1-Arm Chair
31x34x35

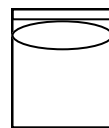
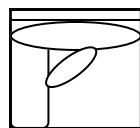

-091 Armless Chair
23x34x35

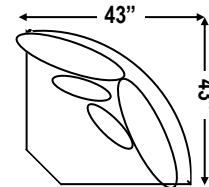

-095 Corner Wedge
43x34x35

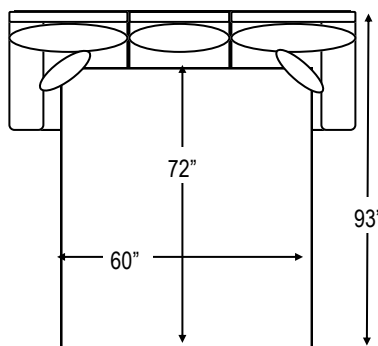

-015 Queen Sleeper
85x34x35

Sleeper mattresses are
72" in length.
Total depth of sleeper
with extended mattress
is 93".
(See diagram on right.)

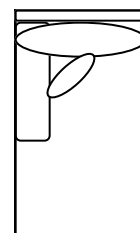

-087 LSF One-Arm Chaise
-085 RSF One-Arm Chaise
33x61x35

